

DETAILS

| | |
|------------------------|--------------|
| Product Number | C10922_GT4-M |
| Family | Gt4 |
| Type | Lens array |
| Color | clear |
| Diameter | 35 mm |
| Height | 9 mm |
| Style | round |
| Optic Material | PMMA |
| Holder Material | |
| Fastening | pin, glue |
| Status | ready |
| ROHS Compliant | Yes |
| Date Updated | 8/03/2014 |



OPTICAL PROPERTIES

| LED | Viewing | Light | Effi- | | Connector |
|---------------------|---------|--------|-----------|------------|-----------|
| | Angle | Beam | ciency | cd/lm | |
| Z5 | sim: 26 | Medium | - | - | - |
| Synios P2720 1/4 mm | sim: 27 | Medium | sim: 94 % | sim: 3.160 | - |
| Oslon SSL 150 | 24 deg | Medium | 89 % | 3.500 | - |
| XB-D | 25 deg | Medium | 92 % | 2.780 | - |
| XP-E | 27 deg | Medium | 86 % | 2.530 | - |
| Oslon SSL 80 | 29 deg | Medium | 87 % | 2.100 | - |
| Double Dome (GM2BB) | 30 deg | Medium | - | - | - |
| LUXEON Rebel ES | 31 deg | Medium | 86 % | 2.090 | - |
| LUXEON A | 32 deg | Medium | - | - | - |
| XP-G | 33 deg | Medium | 85 % | 1.870 | - |

D

C

B

A

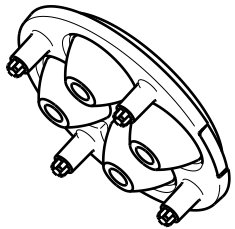

Isometric view
Scale: 1:1

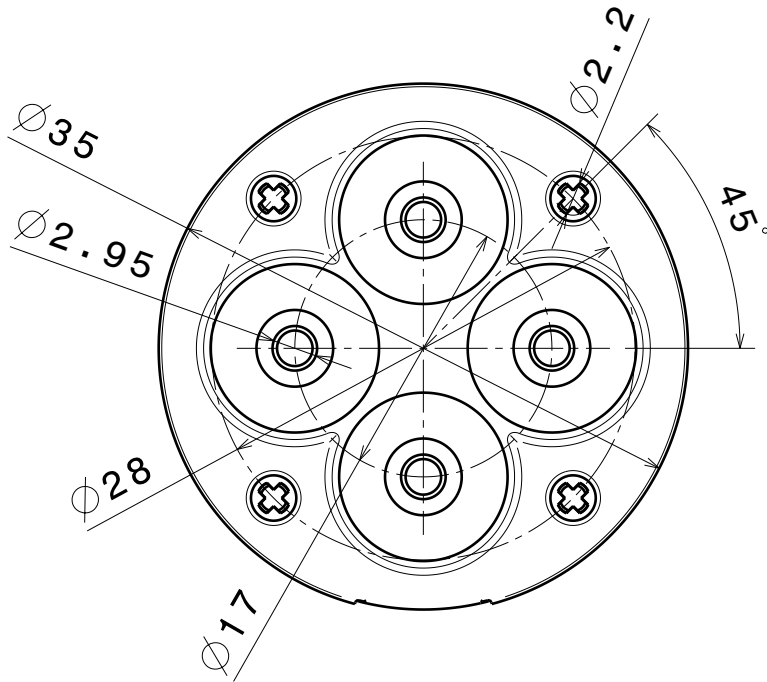

Bottom view

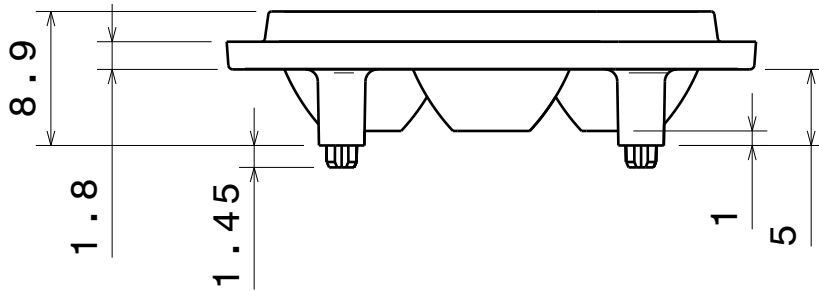

Front view

Material: PMMA

This drawing is our property.
It can't be reproduced
or communicated without
our written agreement.



L
T
F
F

e
e
i
i
N
n

d

DRAWING TITLE

Datasheet GT4-XP series Lens

DRAWN BY

DATE

p

30.12.2009

CHECKED BY

DATE

s

n

23.12.2009

DESIGNED BY

DATE

hh

23.07.2009

SIZE

A4

DRAWING NUMBER

C10921

REV

1

SCALE

2:1

WEIGHT (g)

SHEET

1/1

D

A

4

4

3

3

2

2

1

1

Ledil Oy C10922_GT4-XP-M C10922_GT4-XP-M / LD

Luminaire: Ledil Oy C10922_GT4-XP-M C10922_GT4-XP-M
Lamps: 4 x Cree XP-E (White)

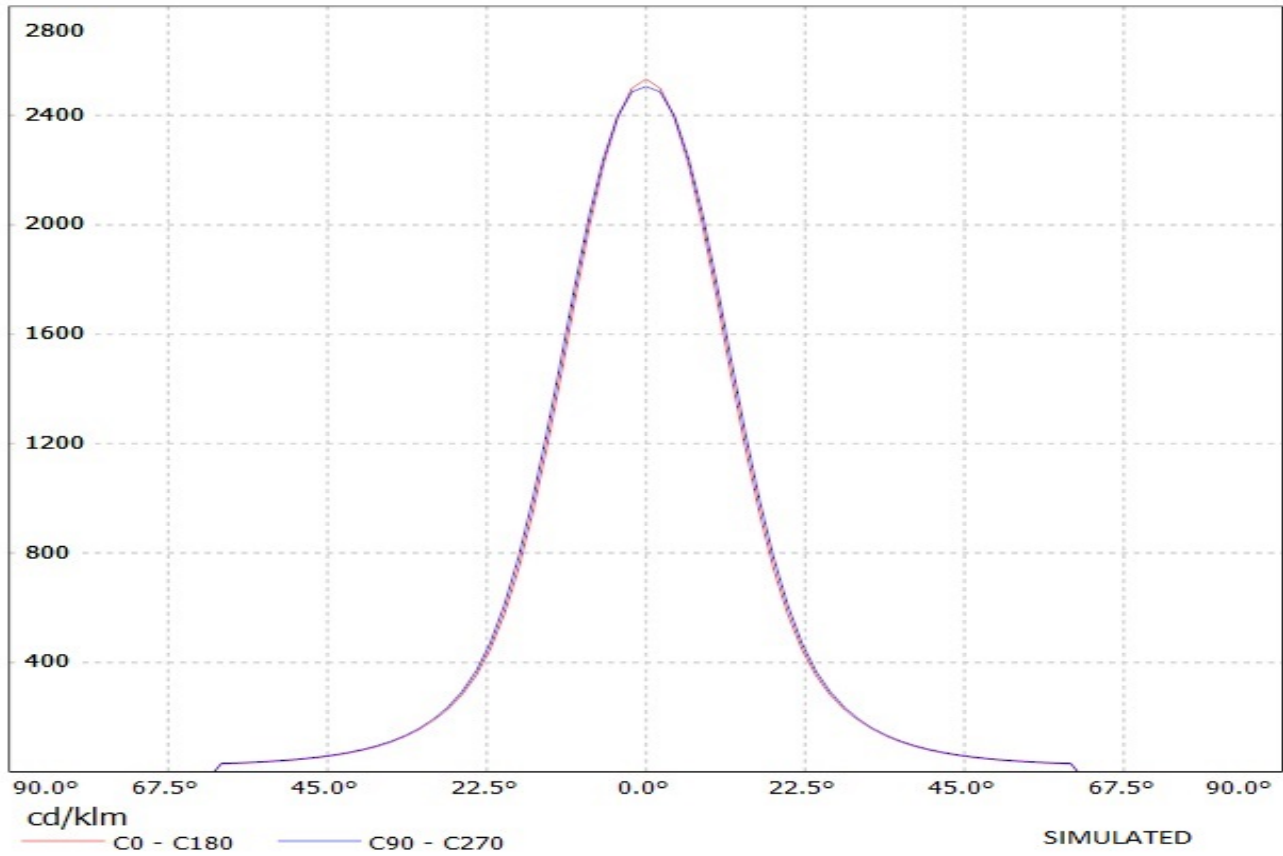

Ledil Oy C10922_GT4-OSL-M C10922_GT4-OSL-M SSL80 333lm @ 250mA LOR=87% / LDC
(Linear)

Luminaire: Ledil Oy C10922_GT4-OSL-M C10922_GT4-OSL-M SSL80 333lm @ 250mA LOR=87%
Lamps: 1 x Osram Oslon SSL80

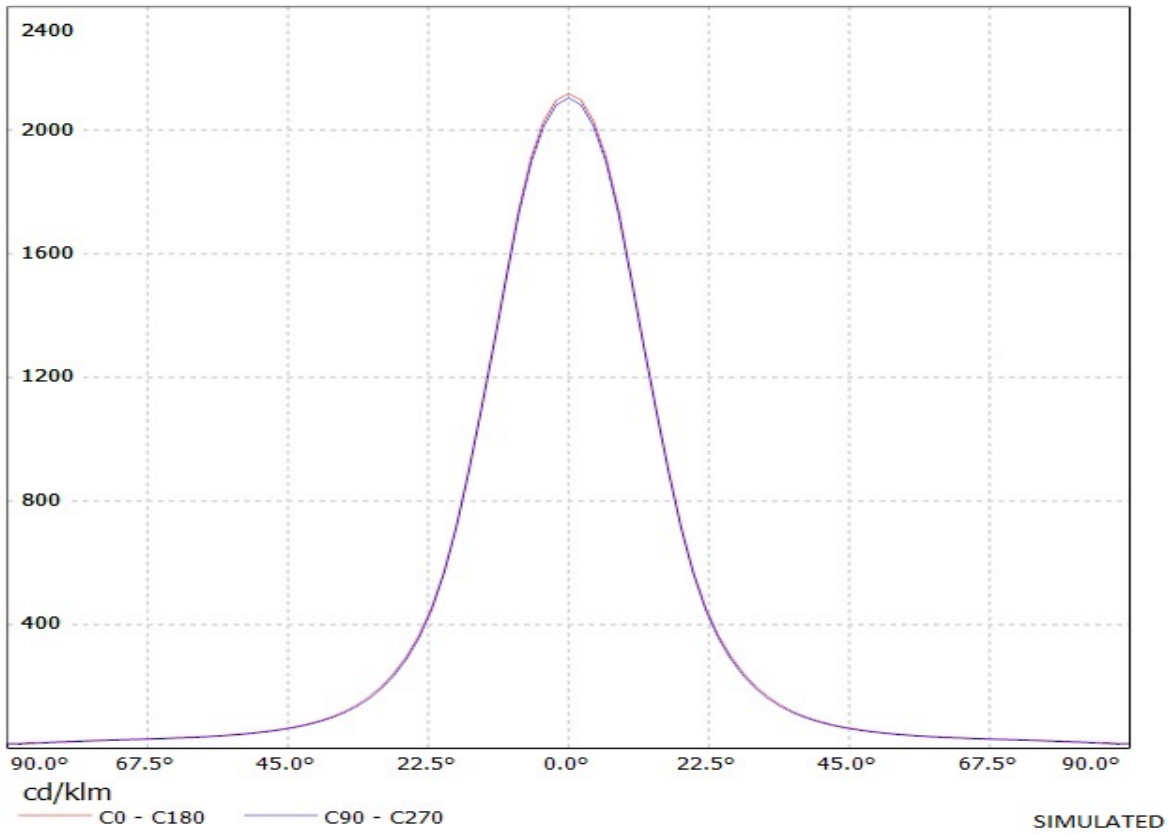

Ledil Oy C10922_GT4-XP-G-M C10922_GT4-XP-G-M / LDC (Linear)

Luminaire: Ledil Oy C10922_GT4-XP-G-M C10922_GT4-XP-G-M
Lamps: 4 x Cree XP-G (White)

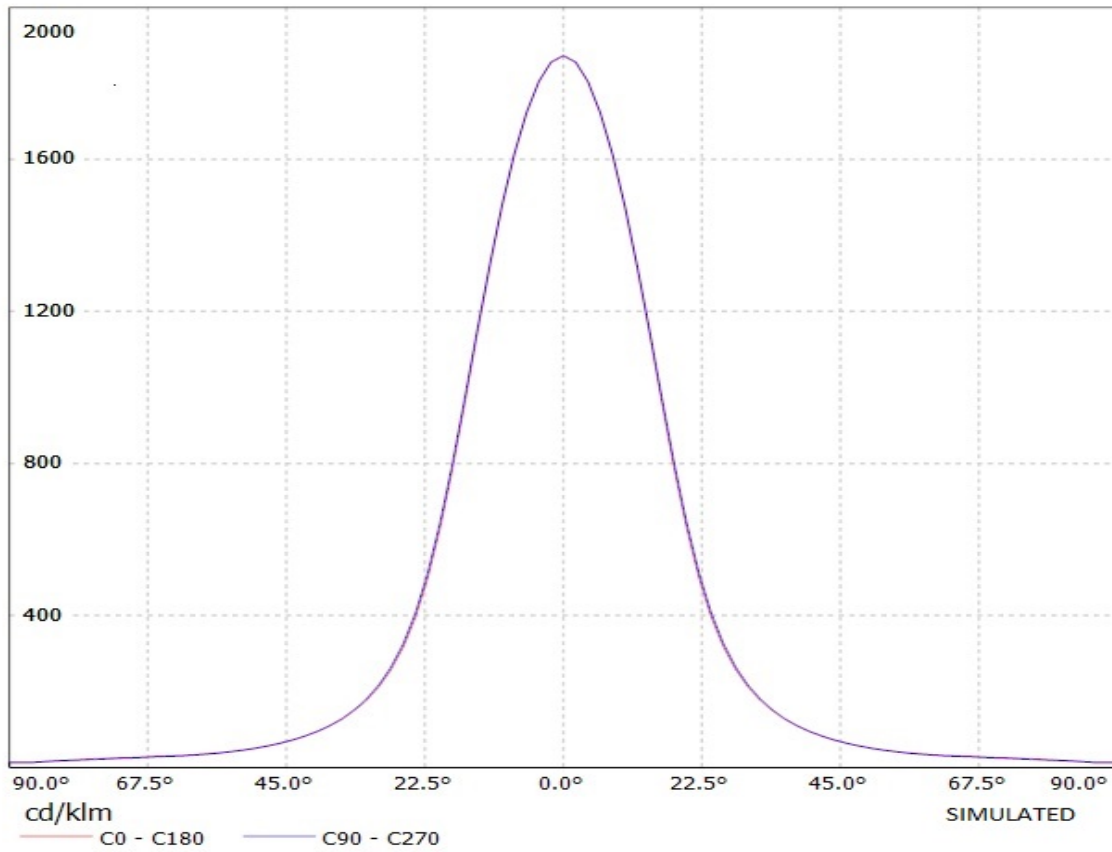

Ledil Oy C10922_GT4-XP-M C10922_GT4-XP-M / LDC (Polar)

Luminaire: Ledil Oy C10922_GT4-XP-M C10922_GT4-XP-M

Lamps: 4 x Cree XP-E (White)

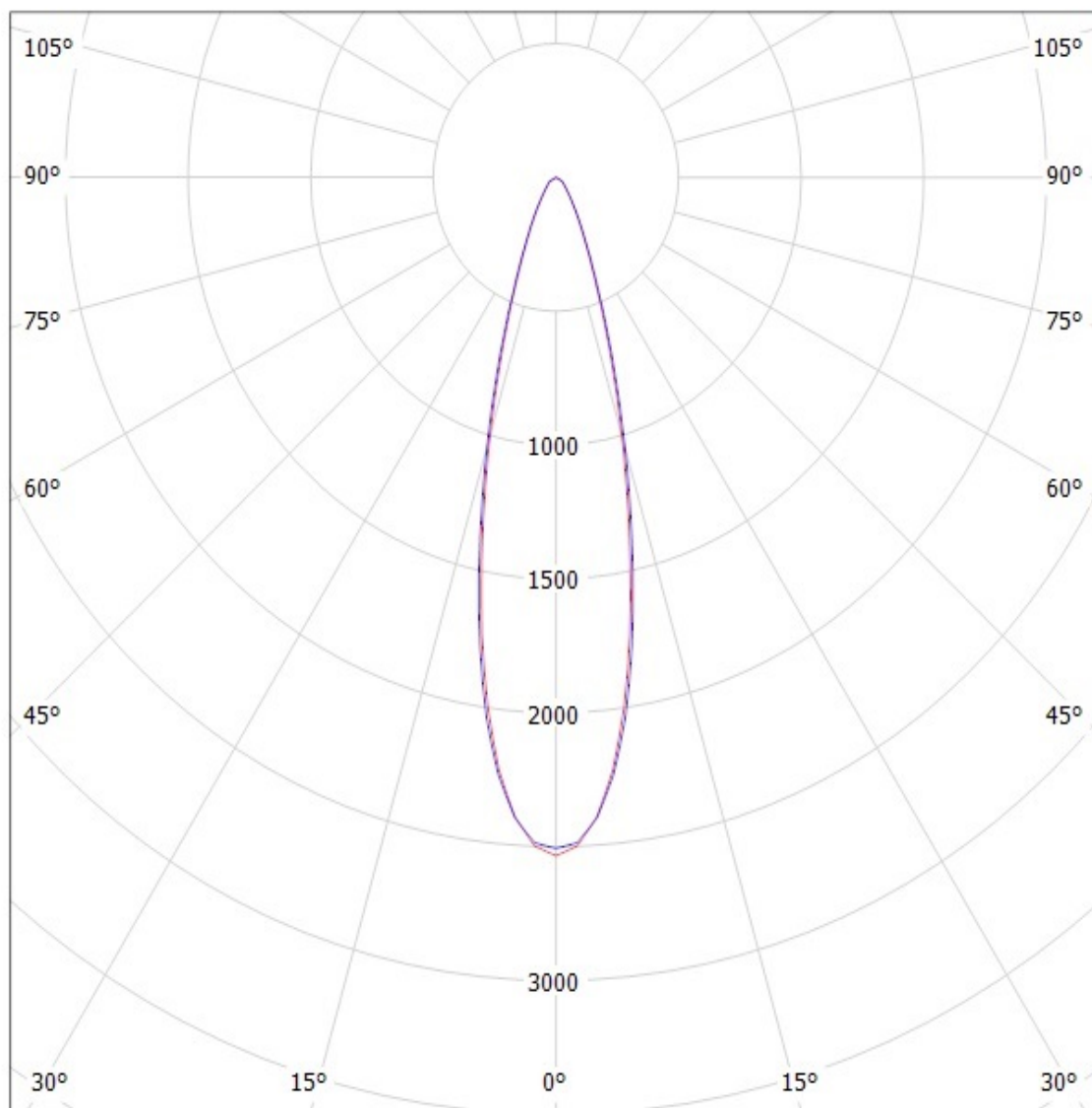

cd/klm

— C0 - C180

— C90 - C270

SIMULATED

Ledil Oy C10922_GT4-OSL-M C10922_GT4-OSL-M SSL80 333lm @ 250mA LOR=87% / LDC
(Polar)

Luminaire: Ledil Oy C10922_GT4-OSL-M C10922_GT4-OSL-M SSL80 333lm @ 250mA LOR=87%
Lamps: 1 x Osram Oslon SSL80

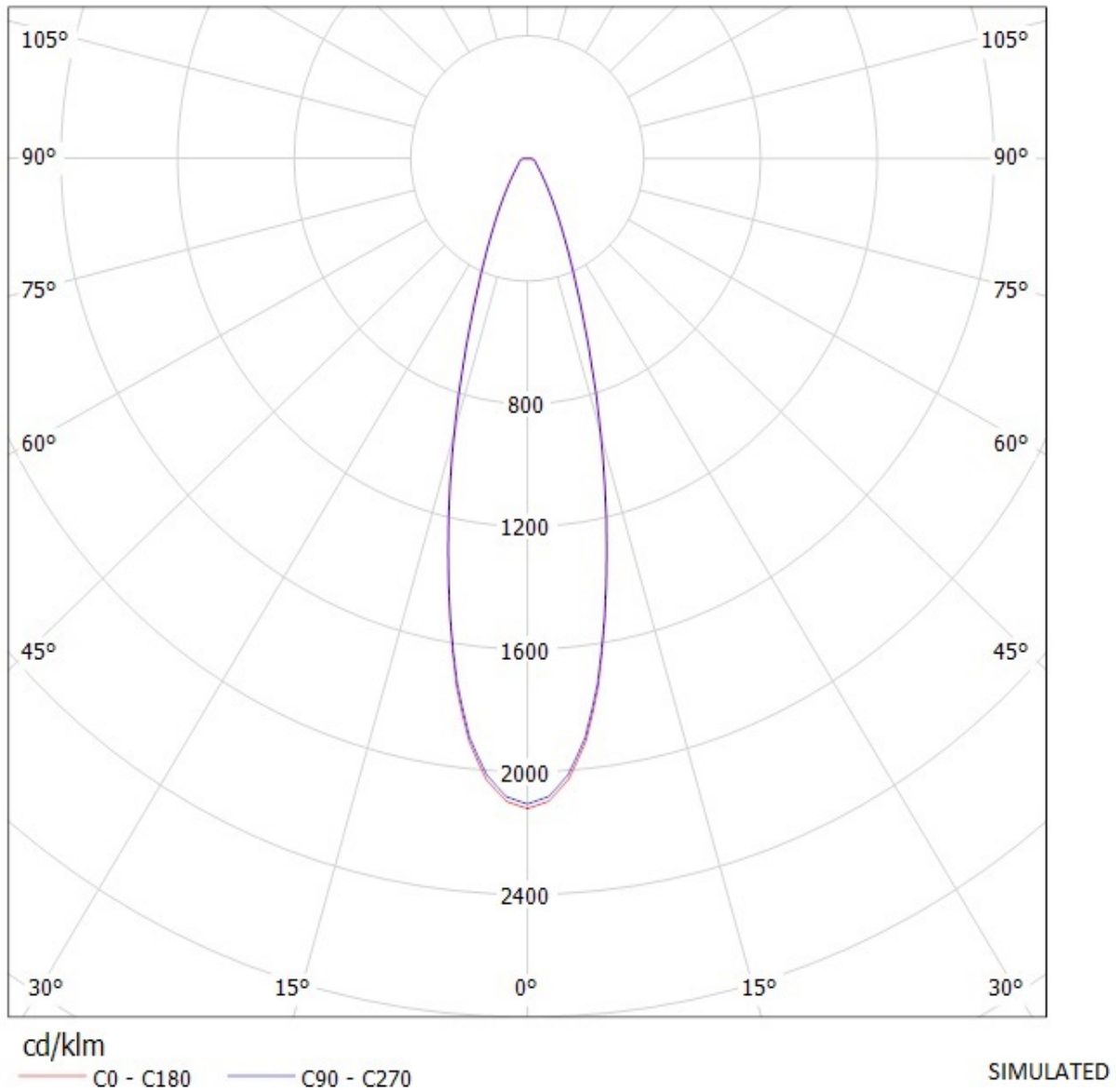

Ledil Oy C10922_GT4-XP-G-M C10922_GT4-XP-G-M / LDC (Polar)

Luminaire: Ledil Oy C10922_GT4-XP-G-M C10922_GT4-XP-G-M

Lamps: 4 x Cree XP-G (White)

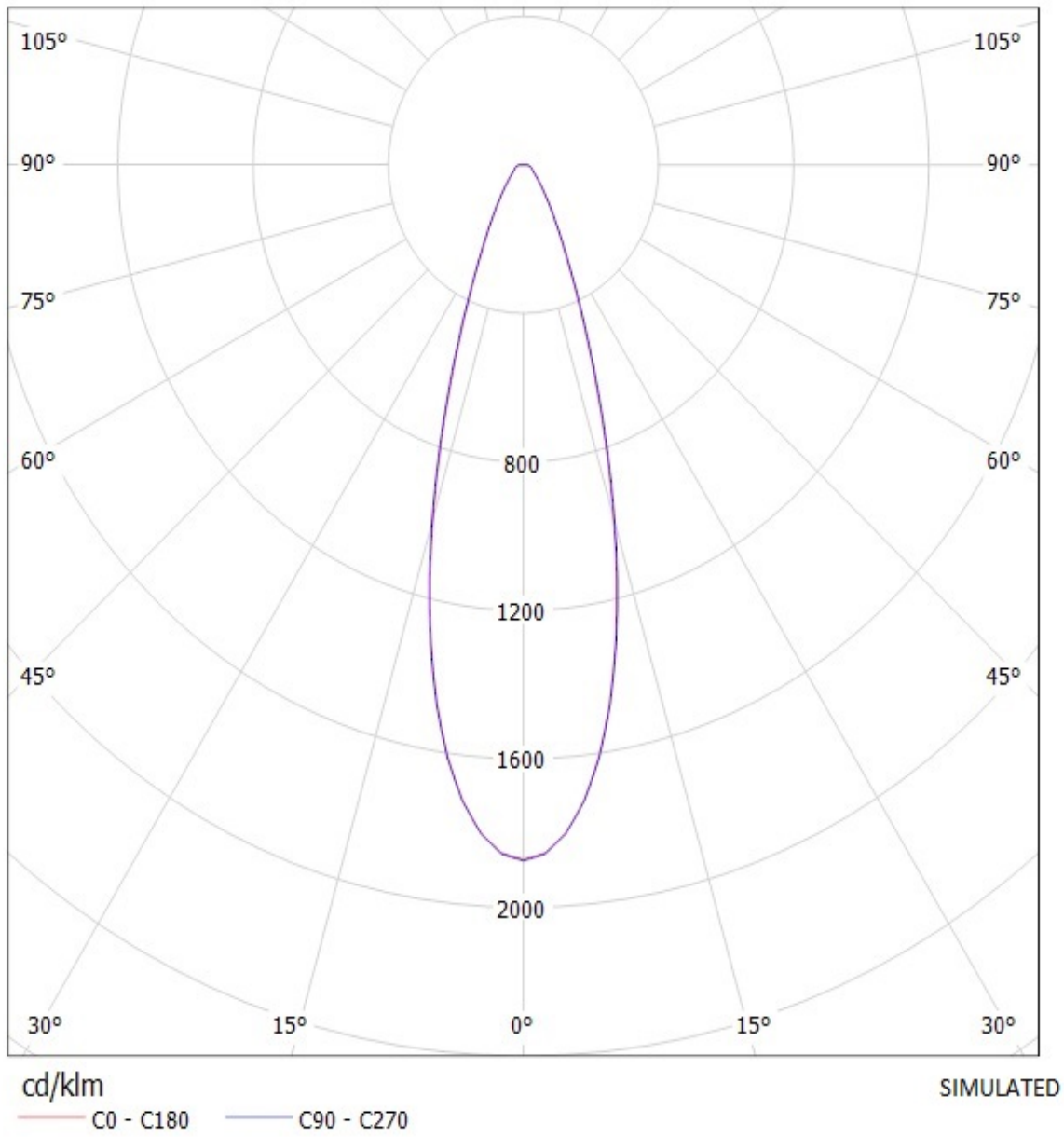

NOTE: The typical divergence will be changed by different color, chip size and chip position tolerance. The typical total divergence is the full angle measured where the luminous intensity is half of the peak value.